

# 交流單相負載電壓、電流、功率、功率因數量測

示意圖：

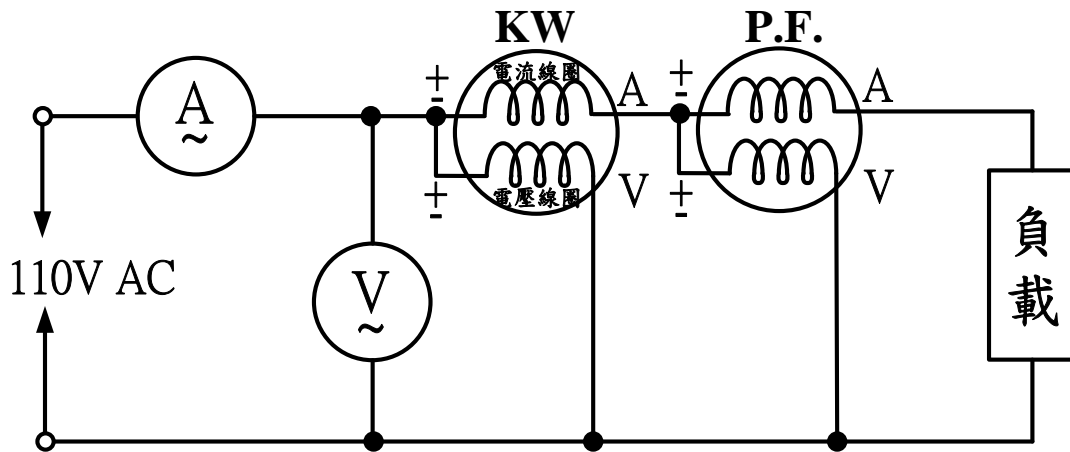

線路圖：



檔位 3

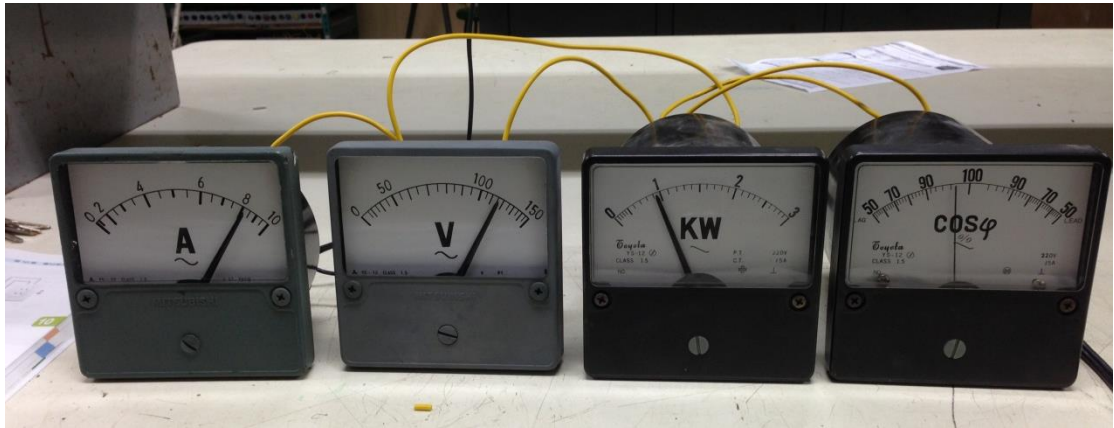

檔位 2

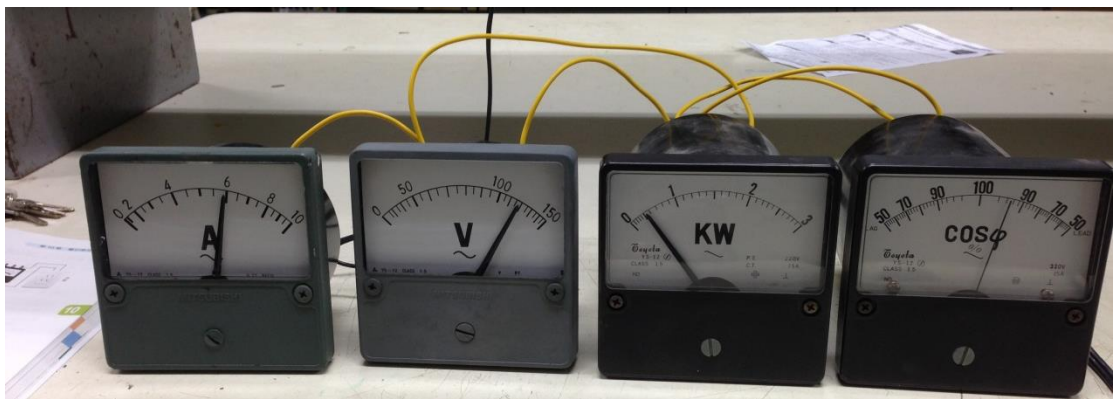

檔位 1

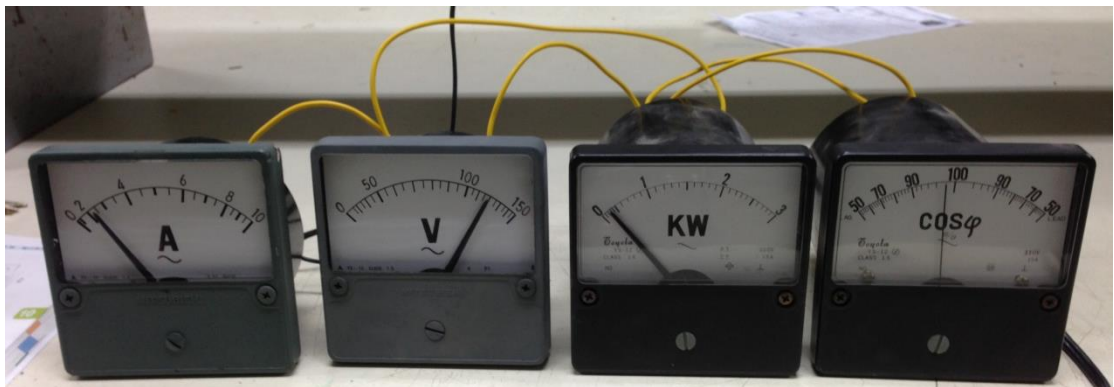

# 用多功能電錶量測

線路圖

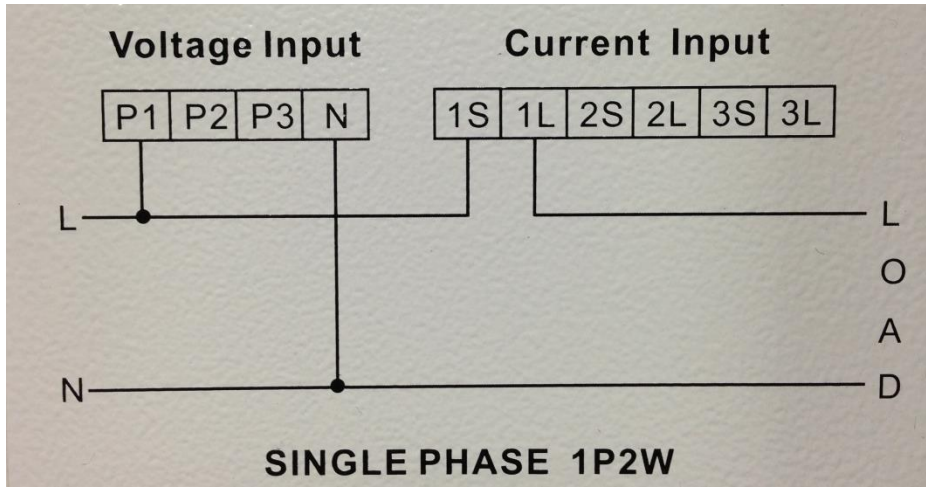

接線圖

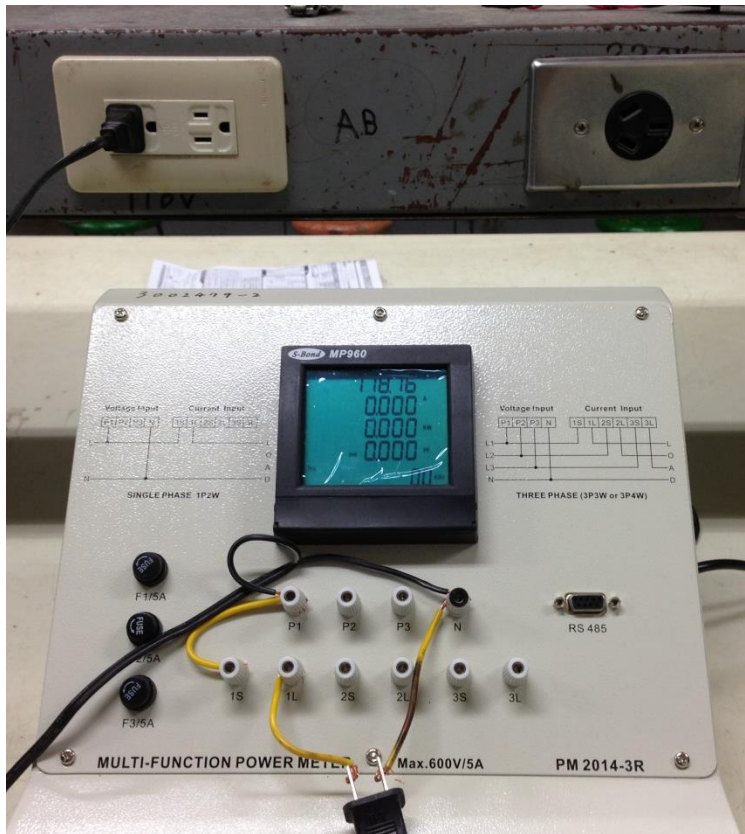

檔位 3

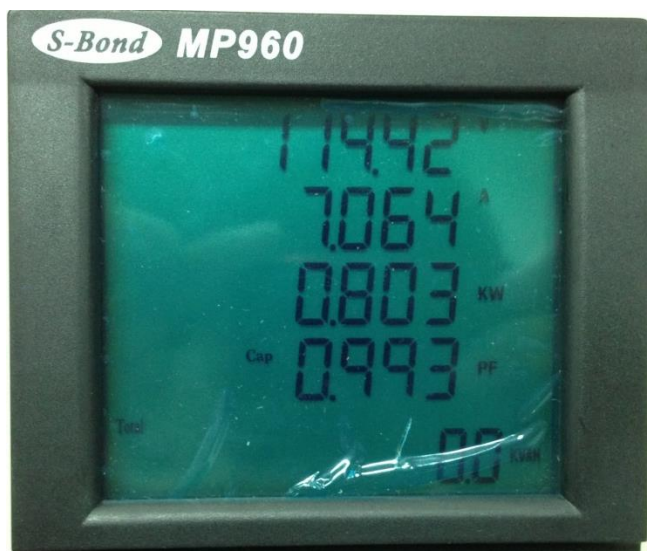

檔位 2

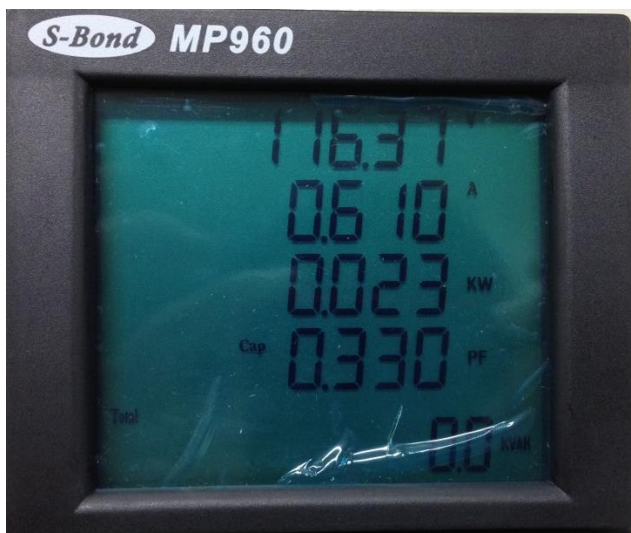

檔位 1

